

IMPORTANCE:

1. These measurements are subject to change or cancellation, no responsibility is assumed for use of superseded or voided pages.
2. Please with consult the manufactory for confirmation of detailed dimensions for bulbing construction purposes.
3. Due to the printing process, tile colors of the actual products may differ from those pictures for true color matching purposes to products chip color samples.

VAANI BATH ENTERPRISES

GSTN:- 27ASDPJ2762P1ZA

Bathroom Product Catalog

Mumbai City Vaani Enterprises Vaanibath co.ltd

**(Address) :- Manokarmna, Hanuman Mandir
Compound, Near Vidya Varidhi
School, Vanotha Pada, Nalasopara
East - 401209**

(E-mail)- info@vaanibath.com

Website- www.vaanibath.com

Mobail No. +91 8433999089

+91 9607999089

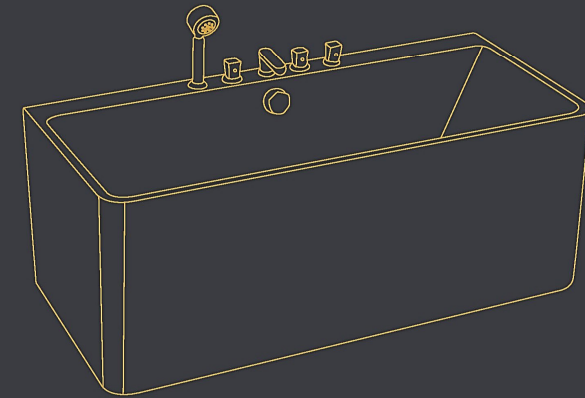







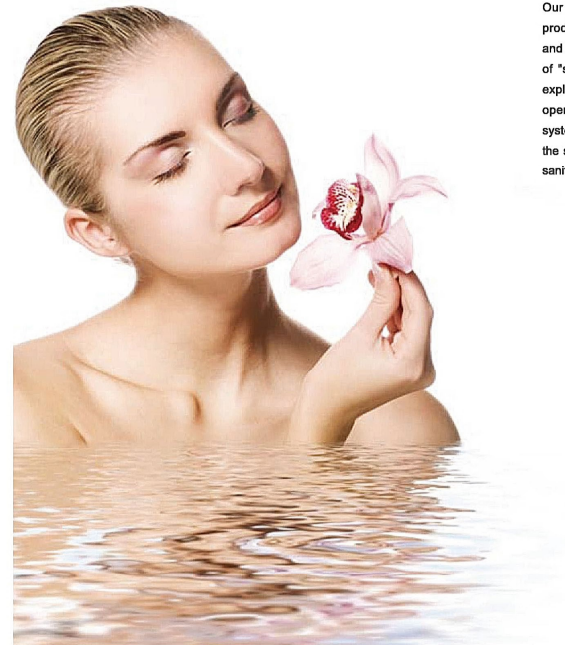







Mumbai City

Company Introduction

Foshan Aowo sanitary ware factory is a professional manufacturer of acrylic massage bathtub, independent bathtub, ordinary bathtub, computer steam bath room, dry and wet steam room, sweat steam room and a series of sanitary products integrating R & D, production, sales and service. With 18 years of bathtub production experience, the company has developed into a large-scale sanitary ware company through continuous renewal and efforts, and the product sales have moved towards the international track. Our company has a set of strict quality management system to control the quality of products, and is deeply welcomed by the majority of merchants with superior quality and preferential price in the market. Our company adheres to the business philosophy of "survival by quality and reputation, improvement by integrity and development by exploration and innovation", and takes its scientific production organization, standard operation mode, advanced management means, perfect and strict quality assurance system and excellent and comprehensive service. All staff will go hand in hand towards the same vision, create brilliance and contribute to the prosperity and development of the sanitary industry.



Contents

	Surfing Massage Pool Series	P01-P20
	Massage Bathtub Series	P21-P81
	Modern Bathtub Series	P82-P108
	Classic Bathtub Series	P109
	Artificial Stone Series	P110-P117
	Transparent resin cylinder series	P118
	Artificial stone pillar basin series	P119-P121
	Concealed Massage Bathtub Series	P122-P134
	Engineering Bathtub Series	P135
	Elderly cylinder series	P136
	Dry And Wet Steam Room Series	P137-152
	Far Infrared Lightwave Room Series	P153-P165
	Steam Room Series	P166-P180
	Floor Faucet Series	P181
	Accessories Series	P182

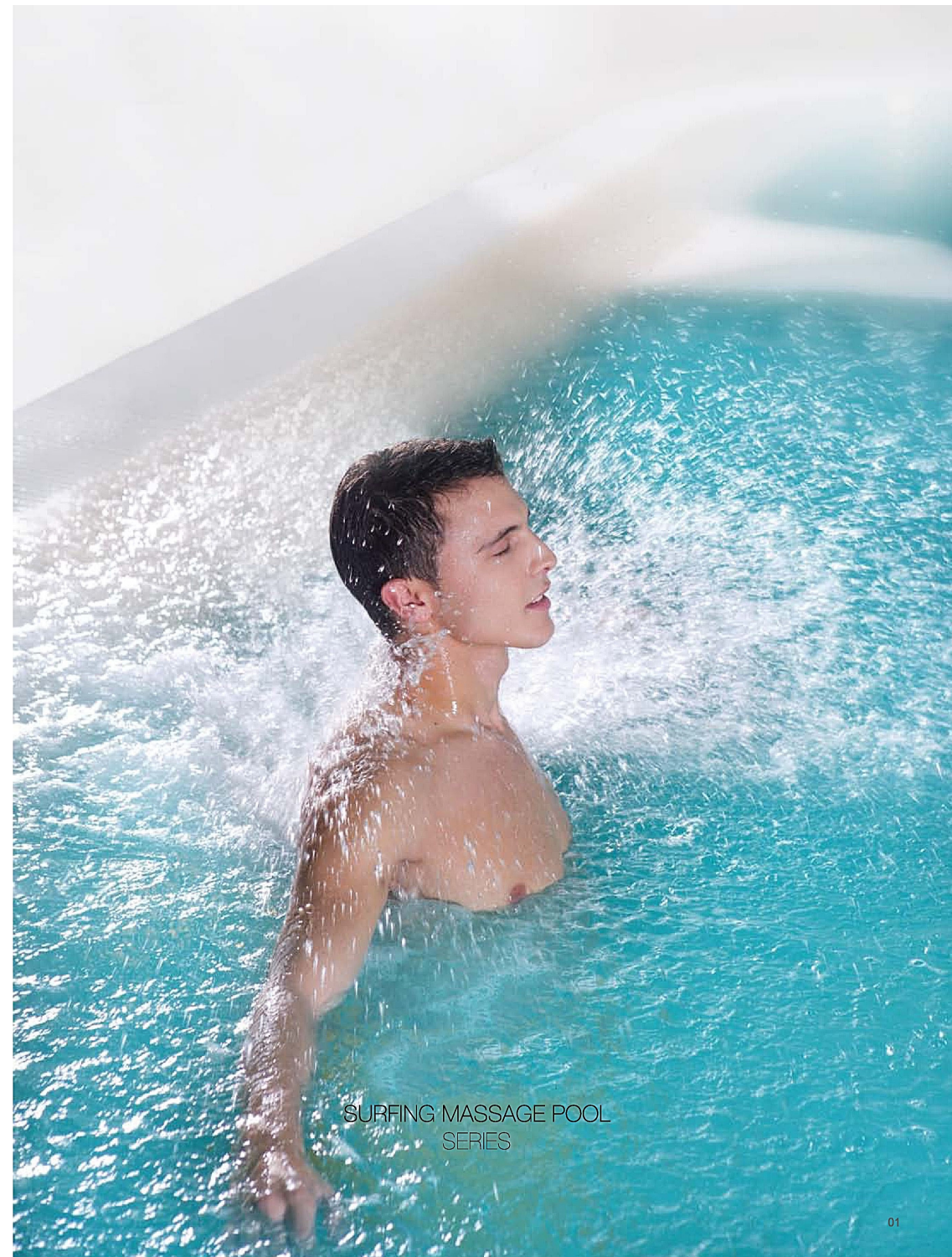

SURFING MASSAGE POOL
SERIES

Big Pool Controller



GD-7005

IMD Technical Features:

Waterproof, flower proof, sunscreen, durable, high temperature resistant and never change color.

Function configuration:

- Intelligent menu control system
- Inductive IMD technology control
- Water pump 1-3
- Circulating pump
- Air pump
- FM radio
- Pool bottom lamp
- External audio input (aux)
- Ozone disinfection
- Constant temperature heating
- Circulating pump loading detection
- Temperature conversion (Celsius / Fahrenheit)
- Temperature error calibration
- Time setting
- Filter cycle can be set
- The filtering time can be set
- Sleep function
- Winter mode
- Anti icing function
- Keyboard lock
- Full function remote control
- Water level detector



GD-730

Full HD, TFT LCD display

Function configuration:

- With WiFi remote app function (optional)
- Surfing function
- Bubble bath function
- Constant temperature heating function
- Underwater lamp function
- Ozone sterilization and disinfection function
- FM radio, Bluetooth, MP3 player
- Radio frequency wireless remote controller
- Air heating equipment control
- Automatic water inlet system
- Automatic drainage system



GD-805

It adopts transparent plastic box, blue background wide screen LCD dynamic display and inductive key control, which is simple and convenient to operate.

Function configuration:

- Microcomputer automatic water level detection Function
- Water pump function
- Air pump function
- Circulating pump function
- Underwater lamp
- Ozone sterilization and disinfection function
- Preset heating constant temperature device (adjustable at 20 °C - 45 °C)
- High sensitivity FM radio system
- Mp3 function with USB socket
- Mobile phone Bluetooth music playback and External audio input interface
- Full function infrared remote control



Model: AO-601

Size: 5800x2200x1350mm

Function configuration:

- Control system 1set
- Swim training system 1set
- Filter pump 1pc
- Water pump 4pcs
- Led light 4pcs
- Total power 6.55KW
- TV (optional)
- DVD player (optional)

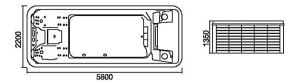

Model: AO-602

Size: 5000x2400x1470mm

Function configuration:

- Control system 1set
- Swim training system 1set
- Filter pump 1pc
- Water pump 4pcs
- Led light 4pcs
- Total power 6.55KW
- TV (optional)
- DVD player (optional)

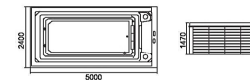



Model: AO-603

Size: 7000x3000x1470mm

Function configuration:

- Control system 1set
- Swim training system 1set
- Water pump 1pc
- Filter pump 1pc
- Jet total 56pcs
- Led light 4pcs
- Total power 11.55KW
- TV (optional)
- DVD player (optional)

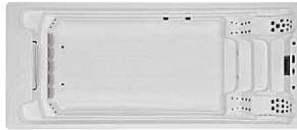
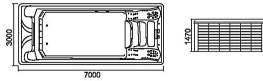

Model: AO-605

Size: 3600x2300x960mm

Function configuration:

- Control panel
- 1x1.0 surf pump
- 2x2.0 surf pump
- Large-size Nozzle for surfing 30pcs
- Small-size Nozzle for surfing 16pcs
- Total power: 14kw
- Return water 2
- 2 Pillows
- Thermostat 2x3.0KW
- Sand tank filter 400#1set
- Electronic sterilizer
- TV (optional)
- DVD player (optional)

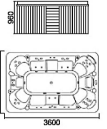

Model: AO-604

Size: 3900x2200x1450mm

Function configuration:

- Control system 1set
- Water pump 3pcs
- Filter pump 1pc
- Jet total 31pcs
- Water column 6pcs
- Led light 2pcs
- Small led 28pcs
- Total power 10.38KW
- TV (optional)
- DVD player (optional)

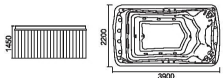
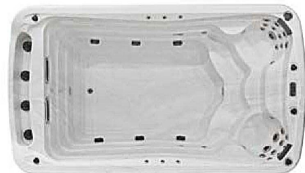

Model: AO-606

Size: 3080x2080x1050mm

Function configuration:

- Control panel
- 2x2.0 surf pump
- 1x1.0 surf pump
- Large-size Nozzle for surfing 19pcs
- Small-size Nozzle for surfing 35pcs
- Total power 7.5KW
- 4 water columns
- Return water 2
- 3 Pillows
- Thermostat 1x3.0KW
- Electronic sterilizer
- Filter 1 set
- Foot pedal
- TV (optional)
- DVD player (optional)

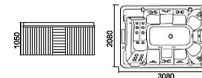



Model: AO-607

Size: 3200x2200x1080mm

Function configuration:

- Rated voltage (with 64A leakage protector)
- Total power 6.8KW
- Water pump 2HPx1 + 0.5HPx1
- Surfing thermostat 3.0KW
- LED colorful color changing lamp
- Sound device
- Disinfection device
- Empty cylinder weight 400kg
- Weight after adding water 1200kg
- Water capacity 800L
- Number of users 6
- Large nozzle configuration
- Small nozzle configuration
- 4pcs air conditioner
- Water distribution regulator
- 1pc water filtration device
- Foot pedal
- Skirt
- Inlet and outlet water configuration
- Pipeline configuration
- TV (optional)
- DVD player (optional)
- For 6persons 4 seats 2 lying

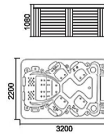

Model: AO-609

Size: 2120x2120x900mm

Function configuration:

- 2x2.0 HP Surfing Pump
- 1x1.0 HP Surfing pump
- 1x700W Wind Pump
- Total power 6.8KW
- Control panel
- Large-size Nozzle for surfing 7pcs
- Small-size Nozzle for surfing 17pcs
- Thermostat
- Dosing Device
- Filter
- Led light 1pcs
- Air Nozzles for bubble bath 10pcs
- TV (optional)
- DVD player (optional)
- For 6persons 5 seats 1 lying

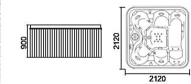

Model: AO-608

Size: 2690x2090x930mm

Function configuration:

- Voltage 220v-240V/50HZ
- Total Power 7KW
- Water Pump 2HPx1+0.5HPx1
- Surfing Thermostat 3.0KW
- LED Color Light
- Purifying Devices
- Air pump 400w
- The Number of Users 8pcs
- Empty Tub Weight 430KG
- Weight With Water 1330KG
- Water Capacity 900L
- The Number of Big Jets
- The Number of Air Adjuster
- The Number of Watershed Regulator
- 1pc The Number of Water Filter
- Skirt
- Water Pass In And Out Configuration
- Pipe Configuration
- LCD Water Proofing Lifting 17-inch
- TV (optional)
- DVD player (optional)
- For 8persons 8seats

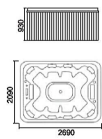

Model: AO-610

Size: 2100x1800x850mm

Function configuration:

- 2x2.0 HP Surfing Pump
- 1x1.0 HP Surfing pump
- 1x700W Wind Pump
- Total power 6.8KW
- Control panel
- Large-size Nozzle for surfing 7pcs
- Small-size Nozzle for surfing 17pcs
- Thermostat
- Dosing Device
- Filter
- Led light 1pcs
- Air Nozzle for bubble bath air jets 10 pcs
- TV (optional)
- DVD player (optional)
- For 4persons 2 seats 2 lying

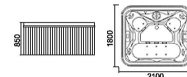



Model: AO-611

Size: 2350x2350x1000mm

Function configuration:

- 2x2.0 HP surf pump
- 1x1.0 HP surf pump
- 1x700W air pump
- Total power 6.8KW
- Control panel
- 8 surfing nozzles
- 34 surfing line nozzles
- Thermostat
- Electronic sterilizer
- Filter
- Led light 1pcs
- Air Nozzle for bubble bath air jets 19pcs
- TV (optional)
- DVD player (optional)
- For 5persons 4 seats 1 lying

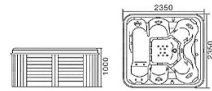

Model: AO-613

Size: 1900x1900x840mm

Function configuration:

- 2x2.0 HP Surfing Pump
- 1x1.0 HP Surfing pump
- 1x700W Wind Pump
- Total power 6.8KW
- Control panel
- Large-size Nozzle for surfing 12pcs
- Small-size Nozzle for surfing 30pcs
- Thermostat
- Dosing Device
- Filter
- Led light 1pcs
- Air Nozzle for bubble bath 19pcs
- TV (optional)
- DVD player (optional)
- For 6persons 5 seats 1 lying

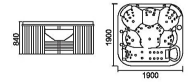

Model: AO-612

Size: 2850x2350x1000mm

Function configuration:

- 2x2.0 HP Surfing Pump
- 1x1.0 HP Surfing pump
- 1x700W Wind Pump
- Total power 6.8KW
- Control panel
- Large-size Nozzle for surfing 8pcs
- Small-size Nozzle for surfing 34pcs
- Thermostat
- Dosing Device
- Filter
- Led light 1pcs
- Air Nozzle for bubble bath 19 pcs
- TV (optional)
- DVD player (optional)
- For 5 persons 3 seats 2 lying

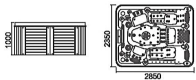

Model: AO-614

Size: 2100x1800x900mm

Function configuration:

- 2x2.0 HP Surfing Pump
- 1x1.0 HP Surfing pump
- 1x700W Wind Pump
- Total power 6.8KW
- Control panel
- Large-size Nozzle for surfing 7PCS
- Small-size Nozzle for surfing 17PCS
- Thermostat
- Dosing Device
- Filter
- Led light 1pcs
- Air Nozzle for bubble bath 10PCS
- TV (optional)
- DVD player (optional)
- For 4persons 2 seats 2 lying

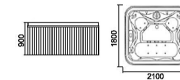



Model: AO-615

Size: 2200x2200x1000mm

Function configuration:

- 2x2.0 HP Surfing Pump
- 1x1.0 HP Surfing pump
- 1x700W Wind Pump
- Total power 6.8KW
- Control panel
- Large-size Nozzle for surfing 11pcs
- Small-size Nozzle for surfing 20pcs
- Thermostat
- Dosing Device
- Filter
- Led light 1pcs
- Air Nozzle for bubble bath 10pcs
- TV (optional)
- DVD player (optional)
- For 7persons 6 seats 1 lying

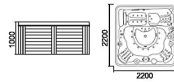

Model: AO-617

Size: 2350x2200x980mm

Function configuration:

- 2x3.0 HP Surfing Pump
- 1x1.0 HP Surfing pump
- 1x700 W Wind Pump
- Total Power 7.5 KW
- Control Panel
- Large-Size Nozzle for surfing 10 pcs
- Small -Size Nozzle for surfing 46 pcs
- Thermostat
- Dosing Device
- Filter
- Led light 1pcs
- Air Nozzle for bubble bath 10pcs
- TV (optional)
- DVD player (optional)
- For 7 persons 6 seats 1 lying

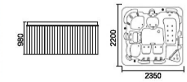
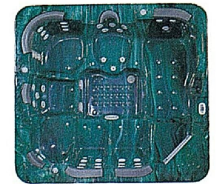

Model: AO-616

Size: 2000x1600x950mm

Function configuration:

- 2x2.0 HP Surfing Pump
- 1x1.0 HP Surfing pump
- 1x700W Wind Pump
- Total power 6.8KW
- Control panel
- Large-size Nozzle for Surfing 1pcs
- Small-size Nozzle for Surfing 30pcs
- Thermostat
- Dosing Device
- Filter
- Led light 1pcs
- Air Nozzle for bubble bath 20pcs
- TV (optional)
- DVD player (optional)
- For 3persons 1 seats 2 lying

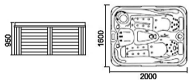
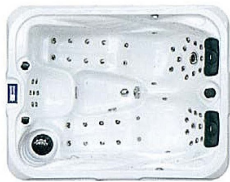

Model: AO-618

Size: 2000x2000x1000mm

Function configuration:

- 2x2.0 HP Surfing Pump
- 1x1.0 HP Surfing pump
- 1x700W Wind Pump
- Total power 6.8KW
- Control panel
- Large-size Nozzle for surfing 11pcs
- Small-size Nozzle for surfing 20pcs
- Thermostat
- Dosing Device
- Filter
- Led light 1pcs
- Air Nozzle for bubble bath 10pcs
- TV (optional)
- DVD player (optional)
- For 5persons 4 seats 1 lying

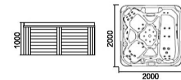



Model: AO-619
 Size: 1900x1350x840mm
 2150x1600x840mm

Function configuration:

- 2x2.0 HP Surfing Pump
- 1x1.0 HP Surfing pump
- 1x700W Wind Pump
- Total power 6.8KW
- Control panel
- Large-size Nozzle for surfing 11pcs
- Small-size Nozzle for surfing 11pcs
- Thermostat
- Dosing Device
- Filter
- Led light 1pcs
- Air Nozzle for bubble bath 12pcs
- TV (optional)
- DVD player (optional)
- For 3persons 2 seats 1 lying

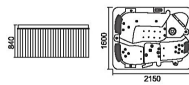

Model: AO-621
 Size: 3560x2050x1020mm

Function configuration:

- Control panel
- 3x1.0 HP surfing pump
- Large-size nozzles for surfing
- Small-size nozzles for surfing
- Total power 8.8kw
- Drain 3pcs
- Pillow 4pcs
- Thermostat 3.0KW
- Dosing Device
- Filter 1set
- Wooden stairs
- TV (optional)
- DVD player (optional)
- For 10 persons 10 seats

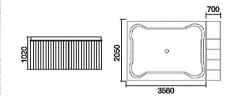
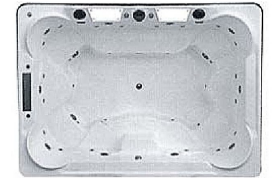

Model: AO-620
 Size: 2000x2000x900mm

Function configuration:

- 2x2.0 HP Surfing Pump
- 1x1.0 HP Surfing pump
- 1x700W Wind Pump
- Total power 6.8kw
- Control panel
- Large-size Nozzle for surfing 12 pcs
- Small-size Nozzle for surfing 6 pcs
- Thermostat
- Dosing Device
- Filter
- Led light 1pcs
- Air Nozzle for bubble bath 18pcs
- TV (optional)
- DVD player (optional)
- For 5 persons 3 seats 2 lying

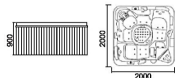

Model: AO-622
 Size: 2900x2050x1000mm

Function configuration:

- control panel
- 3x1.0 HP surf pump
- Large-size Nozzle for surfing 5pcs
- Small-size Nozzle for surfing 30pcs
- needle nozzles 10pcs
- Total power 6.8kw
- Return water 2pcs
- Pillows 2pcs
- Thermostat 3.0kw
- Electronic sterilization
- Filter 1set
- TV (optional)
- DVD player (optional)
- For 5 persons 3 seats 2 lying

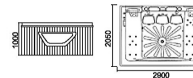



Model: AO-623

Size: 1900x1900x920mm

Function configuration:

- 2x2.0 HP surf pump
- 1x1.0 HP surf pump
- 1x700w air pump
- Total power 6.8kw
- Control panel
- Large-size Nozzle for surfing
- Small-size Nozzle for surfing
- Thermostat
- Electronic sterilizer
- Filter
- Led light 1pcs
- Air Nozzle for bubble bath
- TV (optional)
- DVD player (optional)
- For 5 persons 4 seats 1 lying



Model: AO-626

Size: 2200x2350x980mm

Function configuration:

- 2x2.0 HP surf pump
- 1x1.0 HP surf pump
- 1x700w air pump
- Total power 6.8kw
- Control panel
- Large-size Nozzle for surfing 8pcs
- Small-size Nozzle for surfing 34pcs
- Thermostat
- Electronic sterilizer
- Filter
- Led light 1pcs
- Air Nozzle for bubble bath air jets 19pcs
- TV (optional)
- DVD player (optional)

Model: AO-624

Size: 2300x2200x950mm

Function configuration:

- 2x2.0 HP surf pump
- 1x1.0 HP surf pump
- 1x700w air pump
- Total power 6.8kw
- Control panel
- Large-size Nozzle for surfing
- Small-size Nozzle for surfing
- Thermostat
- Electronic sterilizer
- Filter
- Led light 1pcs
- Air Nozzle for bubble bath
- TV (optional)
- DVD player (optional)
- For 6 persons 5 seats 1 lying

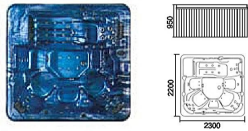

Model: AO-627

Size: 1950x1150x850mm

Function configuration:

- control panel
- 2x1.0 HP surf pump
- Large-size Nozzle for surfing
- Small-size Nozzle for surfing
- Total power 6.8kw
- Backwater
- Pillow
- TV (optional)
- DVD player (optional)

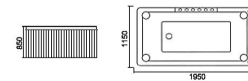

Model: AO-625

Size: 2150x1700x920mm

Function configuration:

- Rated voltage (with 64a leakage protector)
- Total power 6.8kw
- Water pump 2HPx1 + 0.5hp x1
- Surfing thermostat 3.0kw
- LED colorful color changing lamp
- Sound device
- Disinfection device
- Weight of empty cylinder 200kg
- Weight after adding water: 600kg
- Water capacity 400L
- Number of users 3
- Large nozzle configuration
- Small nozzle configuration
- 2pcs air conditioner
- Water distribution regulator
- 1pc water filtration device
- Foot pedal
- Skirt
- Inlet and outlet water configuration
- Pipeline configuration
- TV (optional)
- DVD player (optional)
- For 3 persons 1 seats 2 lying



Model: AO-628

Size: 1900x1600x850mm

Function configuration:

- control panel
- 2x1.0 HP surf pump
- Large-size Nozzle for surfing
- Small-size Nozzle for surfing
- Total power 6.8kw
- Backwater
- Pillow
- 17 inch lifting LCD TV
- TV (optional)
- DVD player (optional)

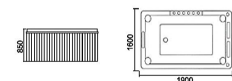



Model: AO-629

Size: 2380x2180x950mm

Function configuration:

- 2x2.0 HP surf pump
- 1x1.0 HP surf pump
- 1x700w air pump
- Total power 6.8kw
- Control panel
- Large-size Nozzle for surfing
- Small-size Nozzle for surfing
- Thermostat
- Electronic sterilizer
- Filter
- Led light
- Air Nozzle for bubble bath
- TV (optional)
- DVD player (optional)

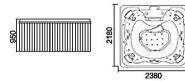
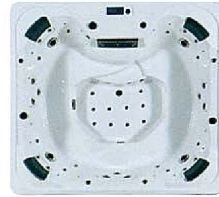

Model: AO-630

Size: 2100x2100x900mm

Function configuration:

- 2x2.0 HP surf pump
- 1x1.0 HP surf pump
- 1x700w air pump
- Total power 6.8kw
- Control panel
- 8 surfing nozzles
- 34 surfing line nozzles
- Thermostat
- Electronic sterilizer
- Filter
- Led light
- Air Nozzle for bubble bath air jets 19
- TV (optional)
- DVD player (optional)

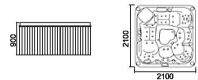

Model: AO-631

Size: 1900x1150x650mm

Left / Right Skirt

Product category (optional): massage cylinder, faucet cylinder, bubble cylinder

Function configuration:

- 1.0 HP surf pump
- Hot and cold water switch
- Portable shower
- Bathub drain
- Surfing nozzle
- Tap
- Pillow
- Control panel (optional)
- Bubble bath (optional)
- Constant temperature (optional)
- Ozone (optional)
- Colorful lamp (optional)
- TV (optional)
- DVD player (optional)



Model: AO-632

Left / Right Skirt

Size: 1860x1500x650mm

Product category (optional): massage cylinder, faucet cylinder, bubble cylinder

Function configuration:

- 1.0 HP surf pump
- Hot and cold water switch
- Portable shower
- Bathub drain
- Surfing nozzle
- Tap
- Pillow
- Control panel (optional)
- Bubble bath (optional)
- Constant temperature (optional)
- Ozone (optional)
- Colorful lamp (optional)
- TV (optional)
- DVD player (optional)



Model: AO-633

Size: 1800x1700x630mm

Function configuration:

- Black acrylic + black ps skirt
- Massage motor 1pc
- Air motor 1pc
- Thermostat motor 1pc
- Computer control panel with bluetooth
- Big massage jets 6pcs
- Small massage jets 12pcs
- Air bubble bath jets & colorful LED lights(bottom)8pcs
- Colorful LED lights around the tub
- Waterfall with LED lights
- Hand shower
- Faucet
- Hot and cold water switch
- Change-over switch
- Drainer
- Pillow 2pcs
- TV (optional)
- DVD player (optional)

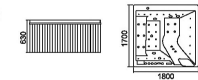



Model: AO-634
Size: 1900x1900x800mm

Function configuration:

- 2x2.0 HP surfing pump
- 1x700w wind pump
- Control panel
- Large-size Nozzle for surfing 6pcs
- Small-size Nozzle for surfing 17pcs
- Total power 6.8kw
- Thermostat
- Dozing Device
- Filter
- Led light
- Air Nozzle for bubble bath 10pcs
- TV (optional)
- DVD player (optional)

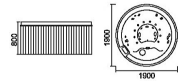

Model: AO-636
Size: 1600x1600x630mm
1800x1800x630mm
2080x2080x630mm

Function configuration:

- 1x1.0 HP Surfing pump
- Cold / hot water switch
- Lift the flower spread
- Drain bathtub
- Surf nozzle
- Waterfalls
- TV (optional)
- DVD player (optional)

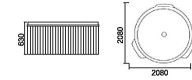

Model: AO-635
Size: 2200x2200x910mm

功能配置: **Function configuration:**

- | | |
|---------------|-----------------------------|
| 国产白色板材 | White color acrylic |
| 控制系统 1套 | Computer control panel 1set |
| 恒温系统 | Thermostat pump |
| PS 塑料裙板 1套 | Outside PS skirt 1set |
| 水泵 2台 | Water pump 2pcs |
| 循环泵 1台 | Circulation pump 1pc |
| 蓝牙系统 1套 | Bluetooth 1set |
| 喷嘴 49个 | Jets 49pcs |
| 过滤器 1套 | Water filter 1set |
| 臭氧 1个 | Ozone 1 set |
| 池底灯 1个 | Bottom Led light 1pcs |
| 冷热喷淋进水 (DN25) | Cold and hot water (DN25) |
| 溢水口 | Overflow |
| 手动排水器 (KF113) | Drainer |
| 夹板包装 | Plywood package |
| 总功率 6.25KW | Total power 6.25KW |
| TV 电视 (可选配) | TV (optional) |
| DVD 机 (可选配) | DVD player (optional) |

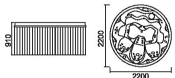

Model: AO-637
Size: 2400x2400x900mm

Function configuration:

- White color acrylic
- Computer control panel
- Thermostat pump
- Bluetooth 1set
- Outside PS skirt
- Water pump 2pcs
- Circulation pump 1pc
- Jets 50pcs
- Water filter 1set
- Ozone 1 set
- Bottom Led light 2pcs
- Cold and hot water (DN25)
- Overflow
- Drainer
- Plywood package
- Total power 6.25KW
- TV (optional)
- DVD player (optional)

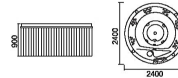

Model: AO-638
Size: 2000x2000x950mm

Function configuration:

- Control panel
- 2x1.0 HP surf pump
- Large-size Nozzle for surfing
- Small-size Nozzle for surfing
- Total power 6.8kw
- Backwater
- Pillow
- Thermostat
- Electronic sterilizer
- Filter 1 set
- TV (optional)
- DVD player (optional)

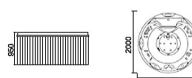



Model: AO-639

Size: 1550x1550x630mm
1700x1700x630mm

Function configuration:

- 1x1.0 HP Surfing pump
- Cold / hot water switch
- Lift the flower spread
- Drain bathtub
- Surf nozzle
- Waterfalls
- TV (optional)
- DVD player (optional)

Model: AO-640

Size: 1050x1050x630mm 1250x1250x630mm
1350x1350x630mm 1450x1450x630mm
1550x1550x630mm 1650x1650x630mm
1750x1750x630mm 1850x1850x630mm
1950x1950x630mm 2050x2050x630mm

Function configuration:

- 1x1.0 HP surfing pump
- Large-size nozzle for surfing 6pcs
- Waterfall
- Cold and hot water faucet
- Color pool lamp
- Bathtub water drainage
- Hydro massage adjustable switch
- Power on/off
- Hydro massage
- Hand shower
- Air bubble(optional)
- TV (optional)
- DVD player (optional)

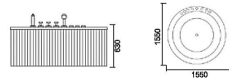

Model: AO-641

Size: 1500x1500x650mm

Function configuration:

- 1x1.0 HP surfing pump
- Large-size nozzle for surfing 6pcs
- Waterfall
- Cold and hot water faucet
- Color pool lamp
- Bathtub water drainage
- Hydro massage adjustable switch
- Power on/off
- Hydro massage
- Hand shower
- Air bubble(optional)
- TV (optional)
- DVD player (optional)

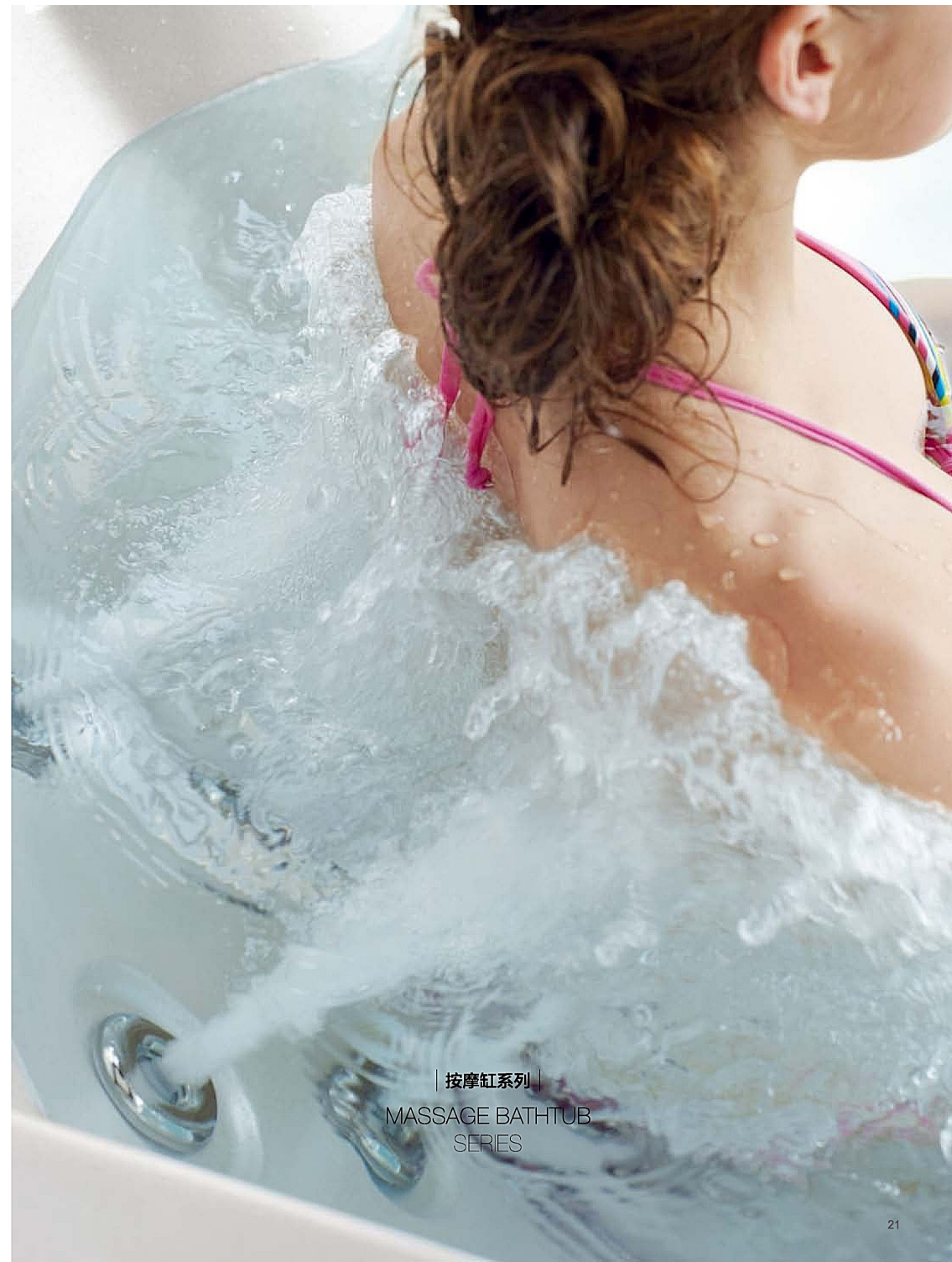
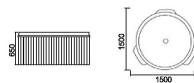

| 按摩缸系列 |

MASSAGE BATHTUB SERIES

Bathtub Technology

SELF CLEAN FUNCTION

The bathtub drain can effectively delay ad hoc three seconds, the bath clean, washed as dirt.

MASSAGE SYSTEM

The electronic numerical control, hydraulic pulse and ergonomics three cross-collar fusion technology to achieve water pressure pulse to bring you feel like hands massage can be a variety of intensity and the way to choose.

CTC THERMOSTATIC CIRCULATION SYSTEM

Water quietly under the guidance of the pump power, quietly flowing, by the instantaneous heating device constantly heating to ensure constant water temperature. Bath for a long time, do not worry about lower water temperature.

SILENT WATER PUMP

Use a dedicated pump, allowing you to enjoy the warm shower time.

STAINLESS STEEL CYLINDER RACK

Bottom of the cylinder with high-quality stainless steel cylinder support, solid and firm, to prevent rust, durable. Cylinder rack four corners can be adjusted Floor mat, you can effectively adjust the uneven ground, a more stable installation of shower basins, more at ease.

FIT THE HUMAN BODY DESIGN

Tubular interior tempered glass fiber criss-cross structure, can withstand a huge impact without deformation.

COLORFUL LIGHT EFFECT

Waterproof LED lights can be issued 7-color light, bringing the beauty of fairy tale dreams.

MULTIPLE SAFETY PROTECTION

The use of fully isolated hydropower design, a number of safety tests and dynamic monitoring of intelligent data security to ensure safety.

TECHNIQUE ADVANTAGE OF BATHTUB

① SPA Massage System Structure Principle

Advocates safe sanitary wares. Bubble bath pipe syste is in strict accordance with standards of authentication of CE safety system of European Union. It has eliminated the hidden hazards of traditional bubble bath system by setting four water proof devices to separate the electricity and water completely.

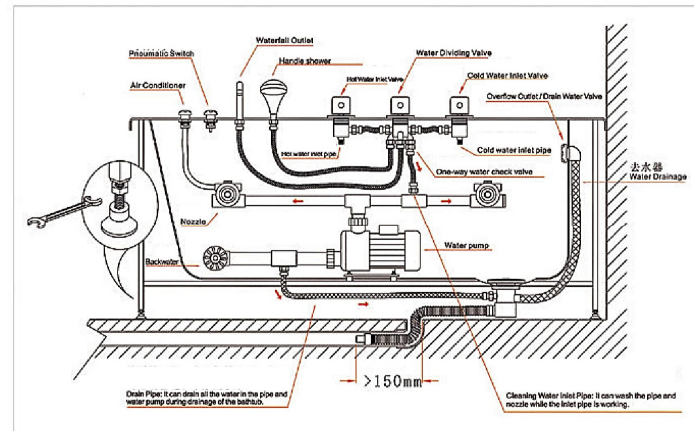

Bubble Bath System Structure Principle

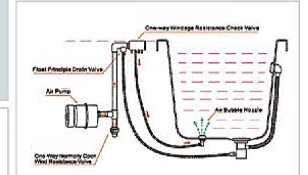

③ Massage Bathtub Hydrograph

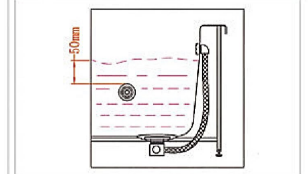

Message Bathtub Controller



GD-375

Function configuration:

- Liquid crystal display
- IMD technology integrated face box
- Inductive key
- Bluetooth music (mp3) playback
- Water pump function
- Constant temperature function
- Air pump function
- Pool bottom lamp function
- Water level detection function
- Ozone disinfection function
- Keyboard lock



GD-805

Characteristics of induction technology:
Waterproof, flower proof, sunscreen, durable, high temperature resistant and never change color.

Function configuration:

- Liquid crystal display
- Full function infrared remote control
- Control induction key
- FM radio
- Sub interface MP3 playback
- External aux input interface
- Water pump function
- Constant temperature function
- Air pump function
- Pool bottom lamp function
- Water level detection function
- Ozone disinfection function
- Keyboard lock

The average thickness of bathtub wall shall be more than 6mm

The drainage is clean, the pipeline is simple, and the unique design prevents the generation of stagnant water and bacteria and ensures health. High-quality pipes and glue, strict test standards to ensure safe use.

Special nozzle for massage bathtub

The powerful spa nozzle inside the Jacuzzi is designed by a famous German teacher. It is completely distributed according to the anatomy of the human body. It can massage the neck, waist and legs of the human body with strong water flow, which can accelerate the blood circulation of the human body and quickly alleviate the fatigue of the human body.

Water Pump

Working principle of massage water pump: the massage water pump sucks the water in the bathtub through the water return device to pressurize, and then chaos is strong mixed water flow of steam and water from the nozzle to impact and massage your different accoints, so as to promote blood circulation and eliminate fatigue. European and American shell design, good heat dissipation performance, low noise, large water flow, excellent quality (CCC certification), stable performance, and the water supply room is completely separated from the room, safe and reliable.